

INTERNATIONAL RECTIFIER



T-25-20

940A RMS Hockey Puk Thyristors

600PE SERIES

Description

The 600PE series of converter type hockey puk thyristors use centre amplified gate junction technology. These devices with their high current capability and small package size are ideal for use in phase control applications in converters, battery chargers, regulated power supplies, lighting circuits and temperature and motor speed control circuits, where compactness is an advantage.

Features

- Centre Amplified Gate
- High di/dt and dv/dt capabilities
- High surge capabilities
- Available up to 1800V V_{RRM} , V_{DRM}
- Fully characterised information

Major ratings and characteristics

	600PE...	Units
$I_T(AV)$	600	A
$I_T(RMS)$	940	A
I_{TSM}	50Hz	6730 A
	60Hz	7040 A
I^2t	50Hz	226,000 A^2s
	60Hz	207,000 A^2s
$I^2\sqrt{t}$	3 200 000	$A^2\sqrt{s}$
V_{RRM}	800 to 1800	V
T_J	-40 to 125	$^{\circ}C$

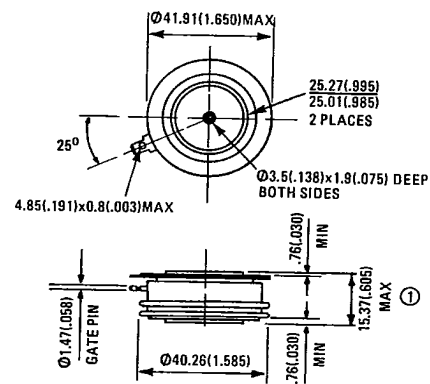

All dimensions in millimeters and (inches)

① - clamped dimension

ELECTRICAL SPECIFICATIONS

Forward conduction

		600PE...		Units	Conditions
$I_T(AV)$	Average on state current	600		A	180° conduction, half sine wave, double side cooled, $T_C = 70^\circ C$
$I_T(RMS)$	Nominal continuous RMS on-state current	940		A	
I_{TRM}	Maximum peak repetitive on-state current	5540		A	30° sinusoidal conduction, $T_C = 70^\circ C$
Mounting force $\pm 10\%$		8920(2000)	4460(1000)	N(lbf)	
I_{TSM}	Maximum peak, one cycle non repetitive on state current	8000	6000	A	$t = 10ms$ No voltage reapplied
		8370	6300	A	$t = 8.3ms$ Sinusoidal half wave
		6730	5050	A	$t = 10ms$ 100% V_{RRM} reapplied
		7040	5300	A	$t = 8.3ms$ Initial $T_J = 125^\circ C$
I^2_t	Maximum I^2_t for fusing	320	180	kA^2s	$t = 10ms$ No voltage reapplied
		292	165	kA^2s	$t = 8.3ms$ Initial $T_J = 125^\circ C$
		226	127	kA^2s	$t = 10ms$ 100% V_{RRM} reapplied
		207	116	kA^2s	$t = 8.3ms$
I^2_{VT}	Maximum I^2_{VT} for fusing	3200	1800	kA^2s	$t = 0.1 - 10ms$, no voltage reapplied
V_{TM}	Maximum peak on state voltage	190		V	$T_J = 25^\circ C$, 180° conduction, $I_{TM} = 7 \times I_T(AV)$ (1885 A peak)
di/dt	Maximum non repetitive rate of rise of turned on current	800		A/ μs	JEDEC STD RS-397, 5.2.2.6: $T_C = 125^\circ C$, $V_{DM} = V_{DRM}$, $I_{TM} = 1800A$ gate source 20V open circuit $20\Omega_r$, $t_r = 0.5\mu s$, $t_p = 20\mu s$
I_H	Maximum holding current	250		mA	$T_J = 25^\circ C$, anode supply = 6V, resistive load, gate open circuit
I_L	Maximum latching current	500		mA	$T_J = 25^\circ C$, anode supply = 6V, resistive load

Triggering

P_{GM}	Maximum peak gate power	10	W	$t_p \leq 5ms$
$P_{G(AV)}$	Maximum average gate power	2	W	$T_J = 25$ to $125^\circ C$
I_{GM}	Maximum peak gate current	3	A	
V_{GM}	Maximum peak gate voltage	20	V	
$-V_{GM}$	Maximum peak negative gate voltage	5	V	
V_{GT}	Maximum gate voltage required to trigger	3.0	V	$T_J = -40^\circ C$
		2.5	V	$T_J = 25^\circ C$
		1.7	V	$T_J = 125^\circ C$
I_{GT}	Maximum gate current required to trigger	300	mA	$T_J = -40^\circ C$
		150	mA	$T_J = 25^\circ C$
		100	mA	$T_J = 125^\circ C$
V_{GD}	Maximum gate voltage that will not trigger	0.2	V	$T_J = 125^\circ C$, rated V_{DRM} applied

Switching

t_d	Maximum delay time	1.0	μs	$T_J = 25^\circ C$, $V_D = 0.8 V_{DRM}$, $I_{TM} = 500A$, gate source 20V open circuit, $R_{source} = 20\Omega$, resistive load, t_r (pulse rise time) 0.5 μs , $t_p = 20\mu s$
t_q	Typical turn off time	220	μs	$T_J = 125^\circ C$, $I_{TM} = 500A$ for 200 μs , $V_R = 50V$ reapplied $dv/dt = 20V/\mu s$ linear to 0.8 V_{DRM} , $di/dt = -25 A/\mu s$
Q_{rr}	Typical stored charge	470	μc	$T_J = 125^\circ C$, $I_{TM} = 400A$, $-di/dt = 20 A/\mu s$

Blocking

dv/dt	Minimum critical rate of rise of off state voltage	500	V/ μs	$T_J = 125^\circ C$, linear to 0.8 V_{DRM} , gate open circuit
---------	--	-----	------------	---

Voltage ratings

Part number	V_{RRM} : maximum repetitive peak reverse voltage $V_S \leq 0$ ①	V_{RSM} : maximum non repetitive peak reverse voltage	V_{DRM} : maximum repetitive peak off state voltage, gate open circuit ①	I_{RM} , I_{DM} : maximum peak reverse and off-state leakage current at V_{RRM} , V_{DRM} , $T_J = 125^\circ C$, gate open circuit
	V	V	V	mA
600PE80	800	800	800	30
600PE100	1000	1100	1000	30
600PE120	1200	1300	1200	30
600PE140	1400	1500	1400	30
600PE160	1600	1700	1600	30
600PE180	1800	1900	1800	30

① For V_{RRM} , $V_{DRM} \leq 1200V$ $T_J = -40^\circ C$ to $125^\circ C$

$>1200V$ $T_J = 0^\circ C$ to $125^\circ C$

For V_{RRM} , $V_{DRM} >1200V$ and $T_J = -40^\circ C$ to $0^\circ C$, derate V_{RRM} , V_{DRM} by 5%

2

THERMAL AND MECHANICAL SPECIFICATIONS

		600PE...	Units	Conditions
T_J	Junction operating temperature range	-40 to 125	$^{\circ}\text{C}$	
T_{stg}	Storage temperature range	-40 to 150	$^{\circ}\text{C}$	
R_{thJC}	Maximum thermal impedance, junction to case.	Single side cooled	0.08	K/W
		Double side cooled	0.04	K/W
R_{thCS}	Maximum thermal resistance, one pole piece to one heat exchanger		0.04 (0.05)	K/W
			0.03 (0.04)	K/W
	Mounting force $\pm 10\%$		1000 (4460)	lbf (N)
			2000 (8920)	lbf (N)
W	Approximate weight		3	oz
			85	g

Fig. 1 – Current Ratings – sinusoidal waveforms, 50–400Hz

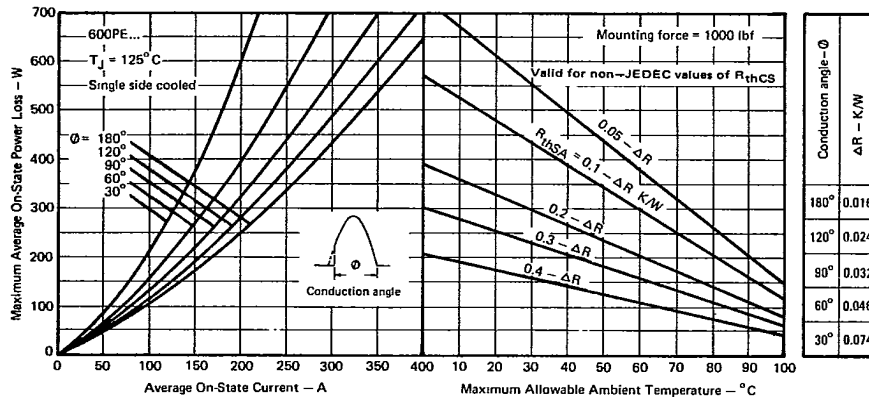
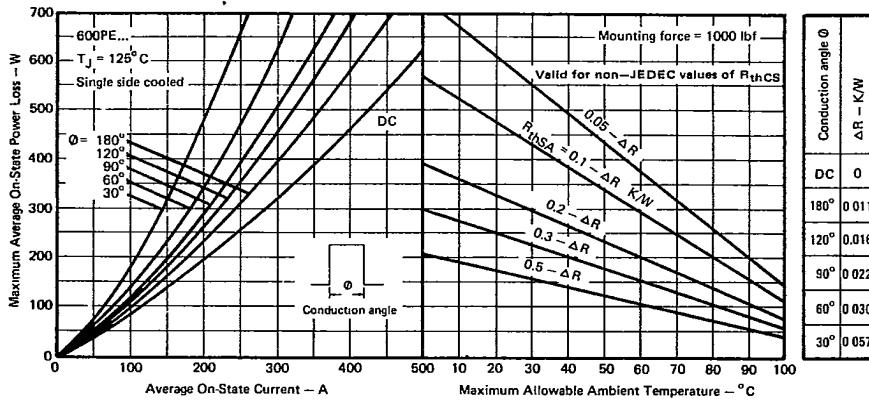

Fig. 2 – Current Ratings – rectangular waveforms, 50–400Hz



3

T-25-20

Fig. 3 – Current Ratings – sinusoidal waveforms, 50–400Hz

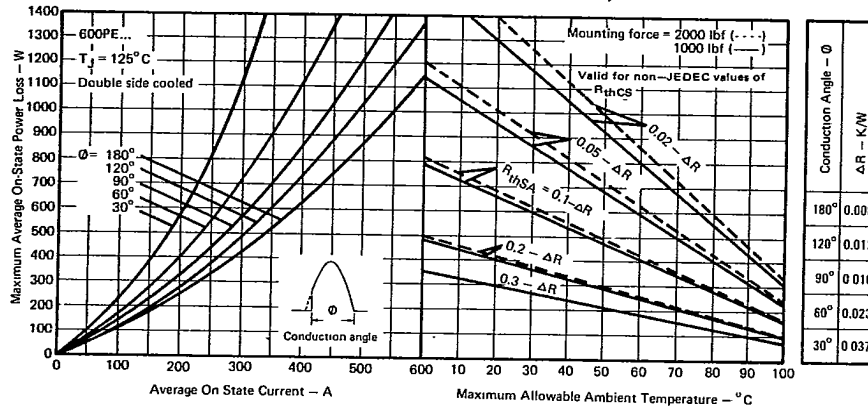

Fig. 4 – Current Ratings – rectangular waveforms, 50–400Hz

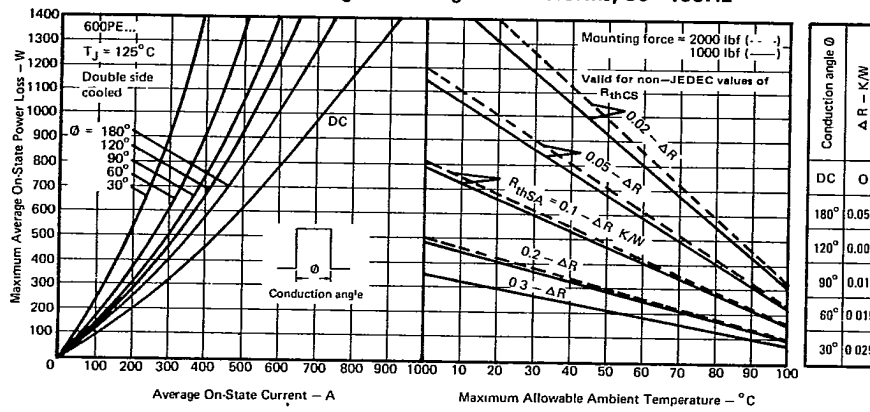

Fig. 5 – Case Temperature Ratings

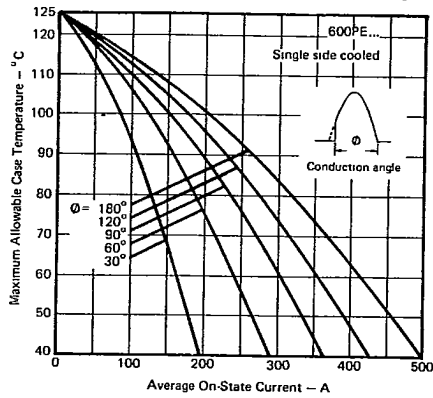
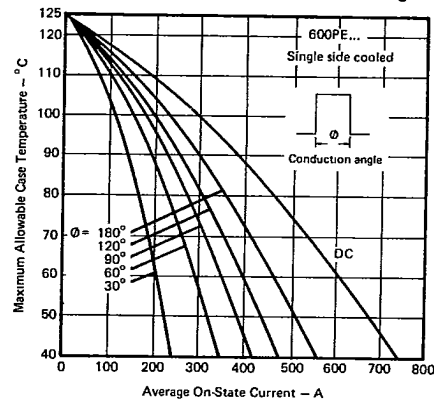

Fig. 6 – Case Temperature Ratings



4

Fig. 7 - Case Temperature Ratings

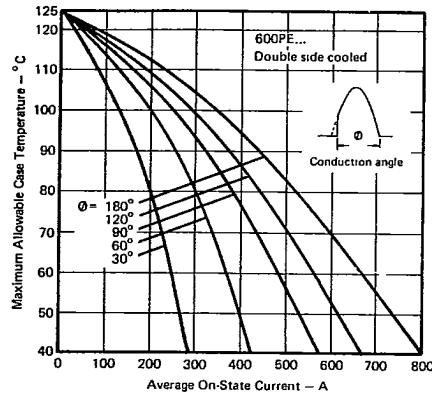

Fig. 8 - Case Temperature Ratings

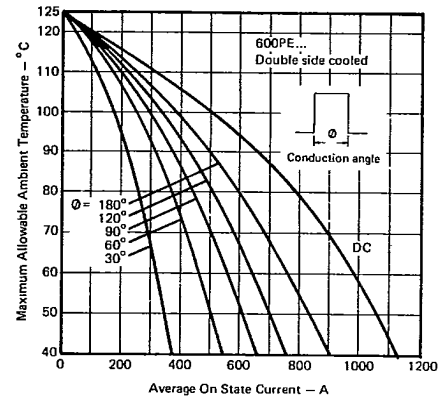

Fig. 9 - Power Loss Characteristics

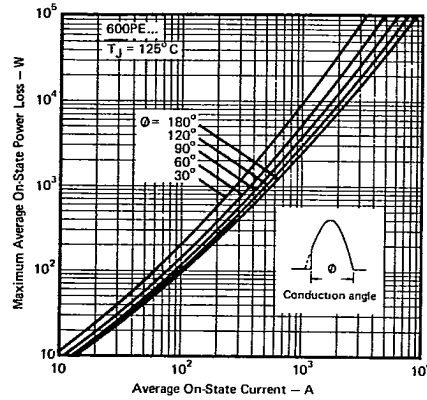

Fig. 10 - Power Loss Characteristics

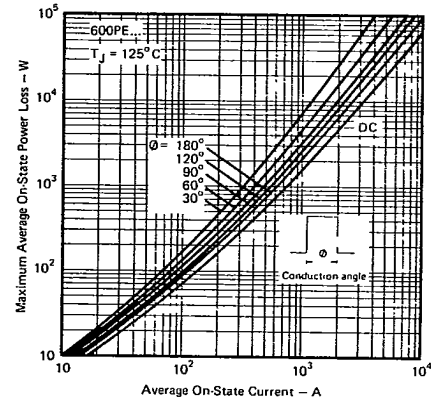

Fig. 11 - On-State Characteristics

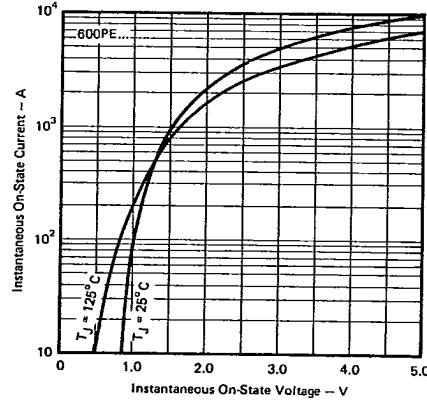
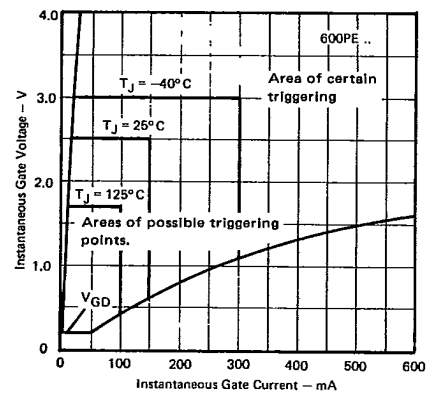

Fig. 12 - Gate Characteristics



5

Fig. 13 – Transient Thermal Impedance

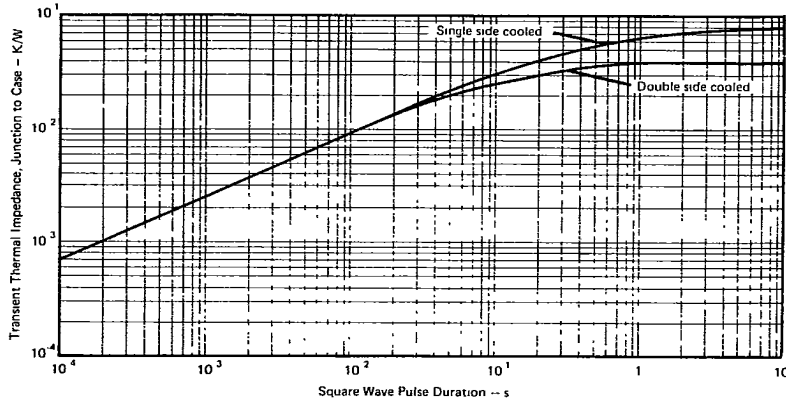

Fig. 14 – Non-Repetitive Surge Ratings

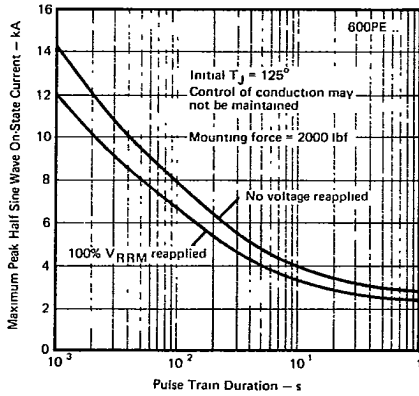
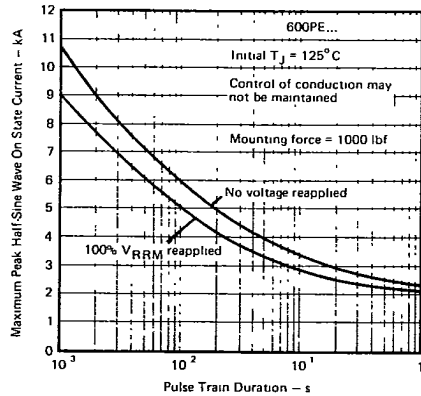

Fig. 15 – Non-Repetitive Surge Ratings



INTERNATIONAL RECTIFIER



WORLD HEADQUARTERS: 233 Kansas St., El Segundo, California 90245. Tel. (213) 772-2000. Tlx. 4720403
 EUROPEAN HEADQUARTERS: Hurst Green, OXTED, Surrey RH8 9BB. Tel. (088 33) 3215/4231. Tlx: 95219

IR CANADA: 101 Bentley St., Markham, Ontario L3R 3L1. Tel. (416) 475-1897. Tlx. 06-966-650, 280 Dorval Avenue, Suite 201A, Dorval, Quebec H9S 3H4
 Tel: (514) 631-4696. Tlx: 05-821726. IR FRANCE: 17 Boulevard Arago, Z.I. De Villeman, 91320 Wissous, France. Tel. 336-920-70-7050. Tlx: 600943 F.
 IR GERMANY: Savignystr. 55, D-6000 FRANKFURT/MAIN 1. Tel. (0811) 74 26 74 Tlx: 04-13123. IR ITALY: Via Ligutia 49, 10071 Bogaro, TORINO.
 Tel. (011) 470 14 84 Tlx: 221257. IR INDIA: International House, LBS Marg, Vikhroli, Bombay 400-083 Tel: (022) 58 15 84. Tlx. 011-2388. IR JAPAN: Daiel
 Building, 23-7 Shinjuku 3-Chome, Shinjuku-ku, Tokyo 160. Tel: (03) 354 8011. Tlx: 232-2994. IR UNITED KINGDOM: Hurst Green, OXTED, Surrey RH8 9BB
 Tel: (088 33) 3215 Tlx: 95219. IR U.S.A. Headquarters: 233 Kansas St. El Segundo, CA 90245 Tel (213) 772-2000 Tlx: 4720403 Central Zone Office: 605
 North Court Suite 150, Palatine, IL 60067. Tel: (312) 991-5520. Tlx: 20-6426. Eastern Zone: 71 Grand Ave., Palisades Park, NJ 07650. Tel. (201) 943-4554.
 Tlx: 13-5477.

Sales Offices, Agents and Distributors in Major Cities Throughout the World.

In the interest of product improvement INTERNATIONAL RECTIFIER reserves the right to change specifications at any time without notice

6